

Softline/Slimline/Frontline Shelving Systems

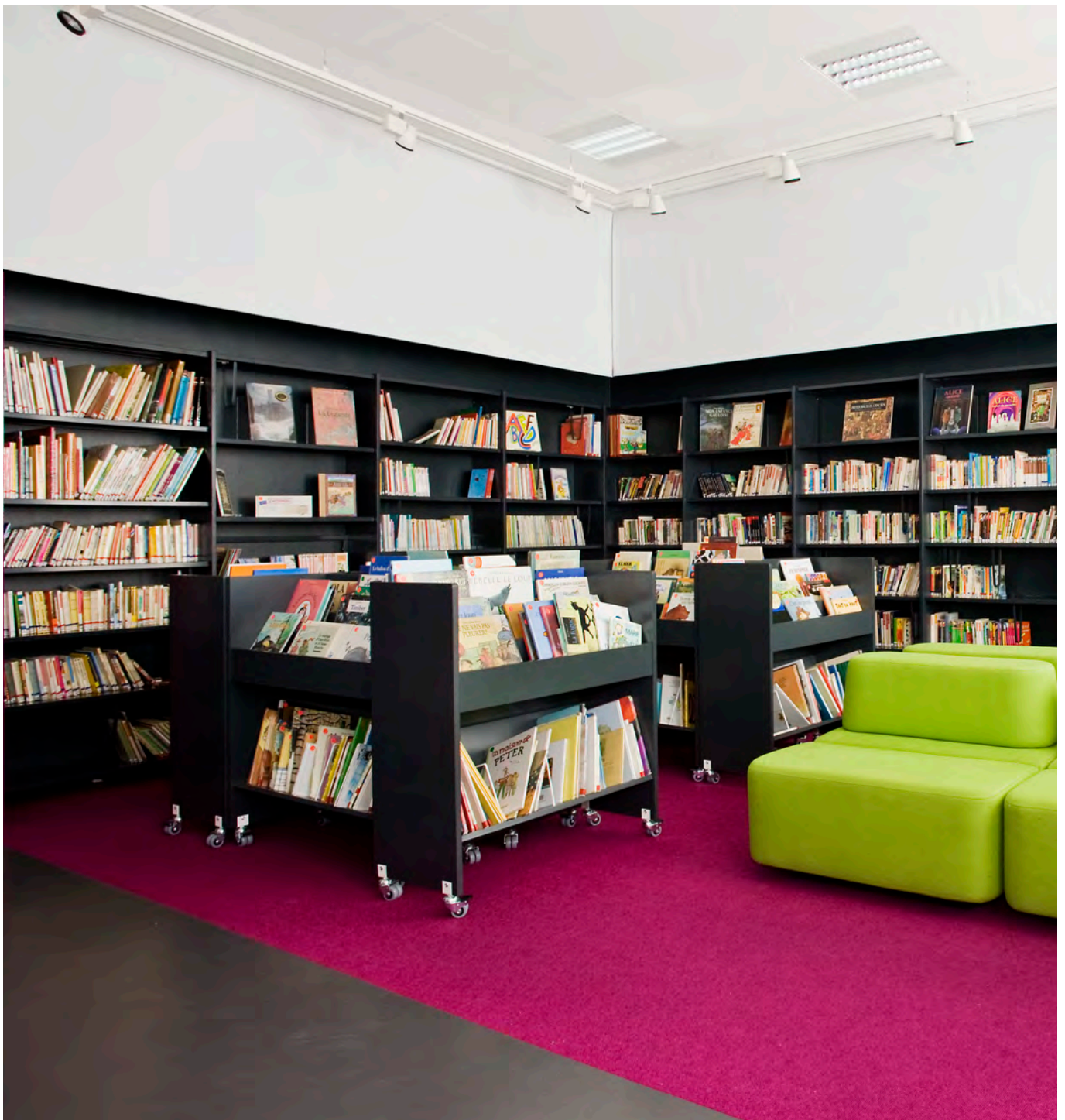

LIBRARY DESIGN

Ever since the start 80 years ago, libraries have been the heart of our business. Libraries and their design are our passion and our mission. Today we are proud to call ourselves library people.

With commitment, curiosity, experience and expertise we develop innovative and functional solutions for today's and tomorrow's libraries.

Our Softline/Slimline/Frontline Shelving Systems are the essence of many years of experience and success. This flexible product concept has evolved over the years and the modular structure and the large number of standard components ensure ideal room utilization and rational accommodation of all relevant functions. In addition the flexibility of the system allows a variety of individual solutions which our design teams bring to life for the individual library.

The Wooden Shelving System is shown in many creative configurations mixed with special developments such as round shelving with seating benches and castors, integrated youth corners with tables and chairs etc. Our broad portfolio of library furniture provides endless possibilities. Please contact our professional sales teams for inspiration.



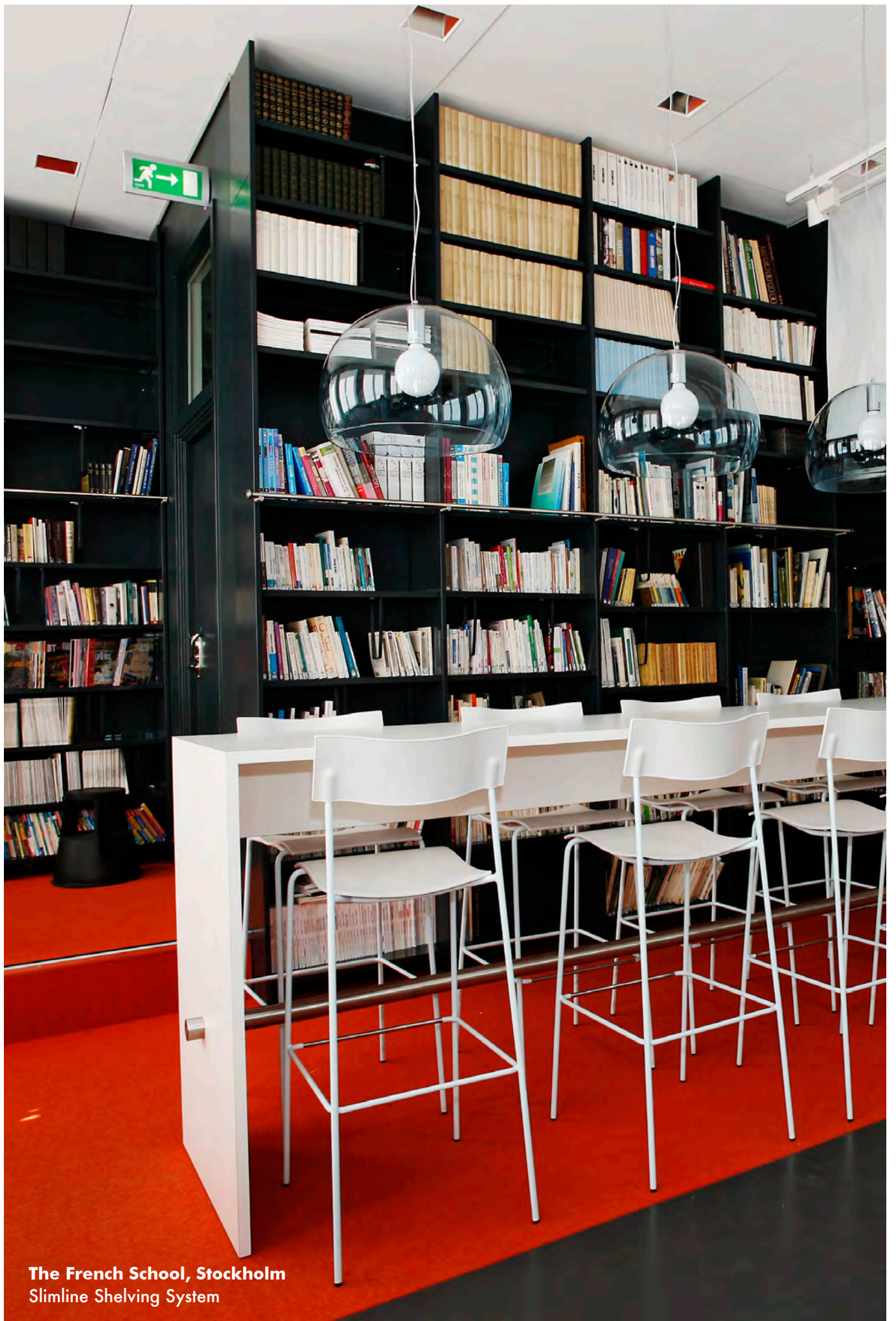

The French School, Stockholm
Slimline Shelving System

TECHNICAL SPECIFICATIONS

Please find technical specifications on all main components for the Softline/Slimline/Frontline Shelving Systems.

DIMENSIONS

Dimensions of complete bays in available modules and heights can be found in each catalogue section which include complete configurations. See index page for overview.

MAXIMUM LOAD

Steel top shelf without backedge - max. load of 25 kg

Shelf with backedge - max. load of 80 kg

Wood top shelf without backedge - blockboard veneered - max. load of 25 kg

Wood shelf with backedge - blockboard veneered - max. load of 80 kg

MOBILE SHELVING UNITS/WHEEL STANDS AND CASTORS

Double-sided shelving units with a max. height of 152 cm and maximum 3 bays can be mounted on wheel stands.

Castors are available with or without brakes. Max. load of 160 kg per castor.

STABILITY

All end panels are provided with adjustable feet that can be adjusted even when the system is loaded.

ROUNDED EDGES

All storage units and brackets have rounded edges.

ASSEMBLY

All wood shelving units come knocked-down followed by assembly guidelines that are easy to follow.

VENEERED WOODEN COMPONENTS

are mainly lacquered with UV-lacquer. See design options for veneer specifications.

PAINTED WOODEN COMPONENTS

are made of MDF (medium density fibre board) which is painted with acid lacquer. See design options for colour specifications.

STEEL POWDER COATING

Steel components are powder coated mainly with thermo hardened polyester powder. Depending on colour choice some powders include epoxy. Thickness of the coating is 60-80 µm. See design options for colour specifications and type of powder.

TECHNICAL SPECIFICATIONS

STEEL METAL FRAMES

are made of 30x20x1.5 mm steel tubes. The metal frame is easy to assemble between the end panels.

STEEL BRACKETS

are made of 1.4 mm sheet steel.

STEEL SHELVES/BROWSERS/CABINETS/PULL-OUT SHELVES

are made of 0.9 mm sheet steel. The flat steel shelves have a 25 mm high front edge. The sloping steel shelves are bent in a way so they have a stopper to prevent magazines from sliding off.

KICKPLATES

are made of 19 mm thick particleboard.

END PANELS

are made of 22 mm thick particleboard of category 1. The particleboard has a density of 610 kgs per cubic meter and the content of formaldehyde shall not exceed 100 grams dry substance. The end panel has two holes in the bottom for adjustable feet that add 20 mm to the end panel height. The end panels allow a wide range of shelves and other functions to be mounted in a row of drilled holes with a distance of 25 mm.

VENEERED BACK PANELS

are made of 16 mm particleboard. The horizontal edges are banded with a 4 mm flat edging of solid wood. The vertical edges are not banded, nor are they exposed after assembly of the back panel. The back panels are surfaced with 0.6 – 0.8 mm thick wood veneer.

PAINTED BACK PANELS

are made of 16 mm MDF.

MELAMINE BACK PANELS

are made of 16 mm particleboard. The horizontal edges are banded with a 4 mm flat edging of ABS. The vertical edges are not banded, nor are they exposed after assembly of the back panel.

VENEERED DISPLAY END PANELS

are made of 22 mm particleboard. All vertical and horizontal edges are banded with a 4 mm flat edging of solid wood. The wood panels are surfaced with 0,6 – 0,8 mm thick wood veneer.

PAINTED DISPLAY END PANELS

are made of 22 mm MDF.

VENEERED WOOD SHELVES

are made of 22 mm block board. The front and back edges are banded with 4 mm thick strips of solid wood. The shelves are surfaced with 0,6 – 0,8 mm thick wood veneer.

VENEERED CORNER SHELF

are made of 22 mm particleboard. The straight edges are banded with 4 mm thick strips of solid wood. The shelves are surfaced with 0,6 – 0,8 mm thick wood veneer (incl. round front edge).

VENEERED WRITING PLATE

are made of 19 mm particleboard. The edges are banded with 4 mm thick strips of solid wood. The shelves are surfaced with 0,6 – 0,8 mm thick wood veneer.

DESIGN OPTIONS

With our Softline/Slimline/Frontline Shelving range you have several design options. The following will give you an overview of our standardized options as to steel and wood colours, fabrics, laminate etc.

We offer more than 60 years of experience with interior design of libraries and development of library furniture. Therefore our creative team will be happy to help you with special requests as to materials not covered by these design options.

Please contact our local sales office for project support and offering.



METAL PARTS

(End panels, crossbars, brackets, shelves, functions, kickplates, light housing)

The metal parts can be powder coated in standard BCI steel colours at no extra charge*

DESIGN OPTIONS

STANDARD STEEL COLOURS



Mango 237



Mandarin 238



Terracotta 239



Oriental red 240



Copper 241



Mulberry red 206



Mahogany 50



Deep purple 242



Coffee 168



Cobalt blue 208



Apple green 90



Fjord 212



Provence blue 213



Navy 243



Racing green 74



Midnight blue 157



Forest green 244



Shadow white 223

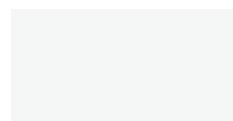

White 222



Steel 220

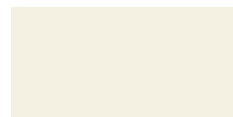

Pearl 217



Graphite grey 224

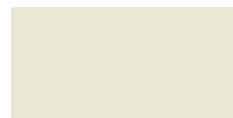

Champagne Mist 25



Concertina grey 229



City grey 236



Gothia grey 233



Antracite 235



Charcoal 23



City black 51



Black pearl 231



Black 232

DESIGN OPTIONS

WOODEN PARTS

(Shelves, end panels, display panels, table tops)

The wooden parts can be manufactured in a number of different lacquered wood veneers.



Ash 68



Beech 70



Birch 69



Oak 66



Maple 67



Light steamed beech 55

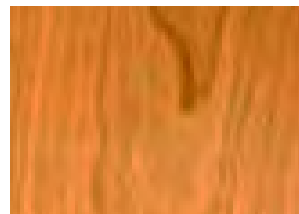

Cherry 54

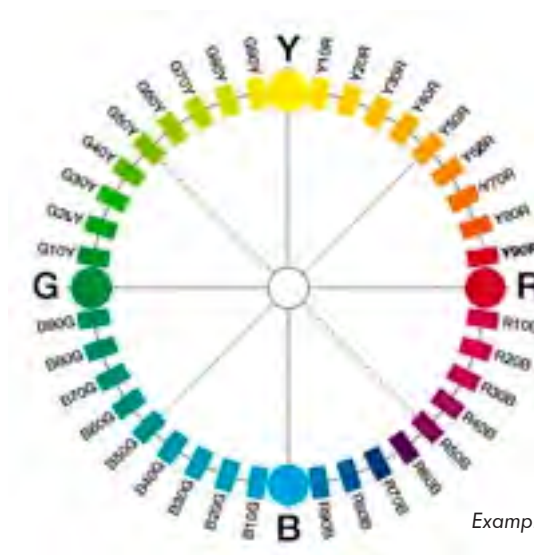

Examples of NCS colours

*A higher surcharge for colours with "metallic" look or different surface textures must be expected.

Please note that wooden components which are to be painted in other colours may be manufactured in MDF. Please note that our wooden shelves and table tops are manufactured with a stronger paint to resist the wear and tear of books sliding across the painted surface. For maximum robustness we recommend laminated wooden shelves. Please be aware that when painted the slats in display end panels may not be fully covered.

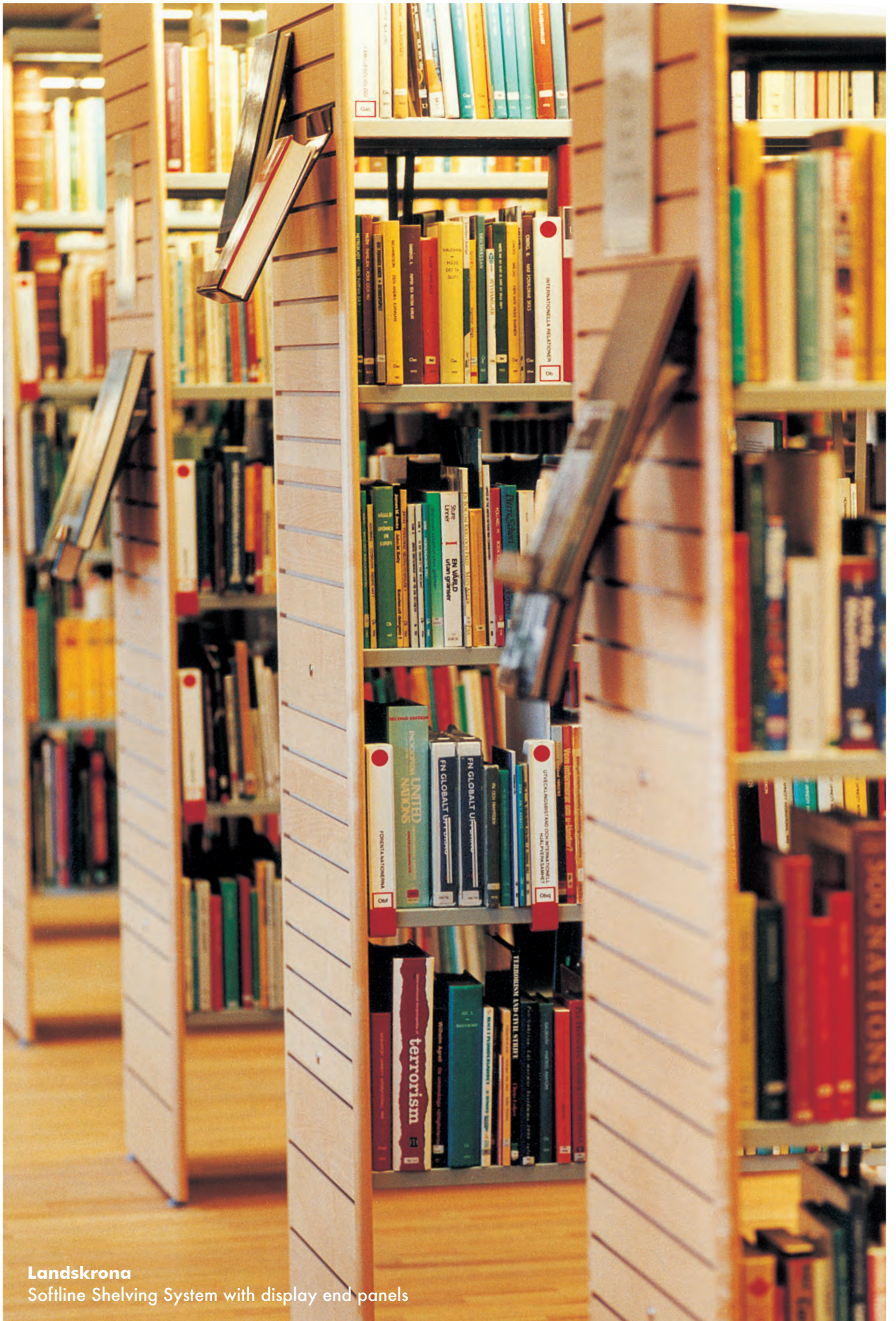

Landskrona
Softline Shelving System with display end panels

SOFTLINE SHELVING SYSTEM

The following pages will show basic configurations of the Softline Shelving System.

Softline comes with a 25 mm superelliptical shaped edging of solid wood. The distance between the front edge of the end panel and the front edge of the shelf is 26 mm.

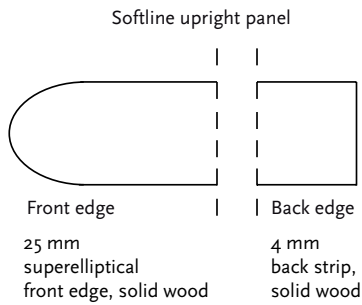

HEIGHTS

Softline shelving comes in 5 heights; 92, 122, 152, 182 and 212 cm. Heights include adjustable feet (max. 2 cm). The shelves are adjustable in 2.5 cm increments.

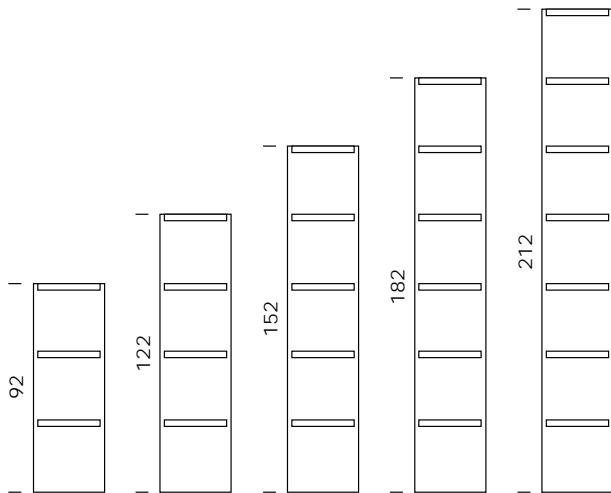

WIDTHS

The bays are available in 75, 90 and 100 cm modules and as starter and add-on bays. A starter bay has two outside end panels while an add-on bay has one intermediate end panel.

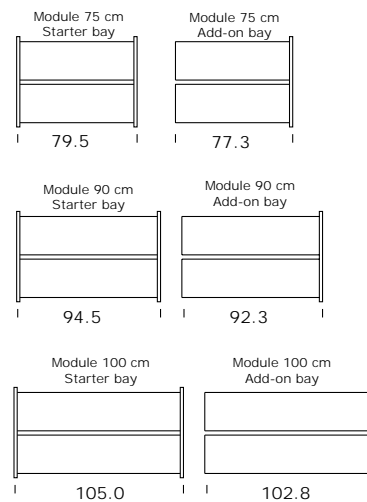

DEPTHS

The end panels come in 6 depths:
 30.8 cm for 25 cm deep shelves
 35.8 cm for 30 cm deep shelves
 45.8 cm for 40 cm deep shelves
 58.9 cm for 2 x 25 cm deep shelves
 68.9 cm for 2 x 30 cm deep shelves
 88.9 cm for 2 x 40 cm deep shelves

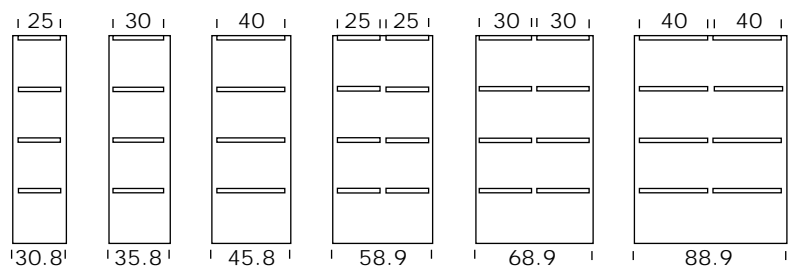



The French School
Slimline Shelving System

SLIMLINE SHELVING SYSTEM

The following pages will show basic configurations of the Slimline Shelving System.

Slimline comes with a 4 mm flat front edge of solid wood. The distance between the front edge of the end panel and the front edge of the shelf is 26 mm.

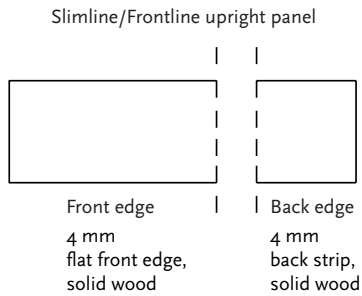

HEIGHTS

Softline shelving comes in 5 heights; 92, 122, 152, 182 and 212 cm. Heights include adjustable feet (max. 2 cm). The shelves are adjustable in 2.5 cm increments.

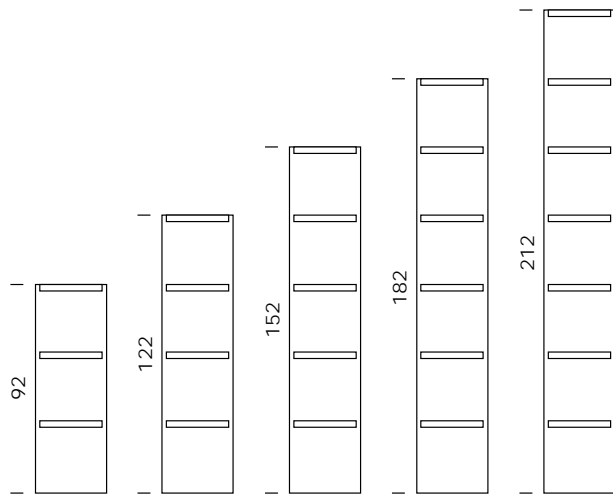

WIDTHS

The bays are available in 75, 90 and 100 cm modules and as starter and add-on bays. A starter bay has two outside end panels while an add-on bay has one intermediate end panel.

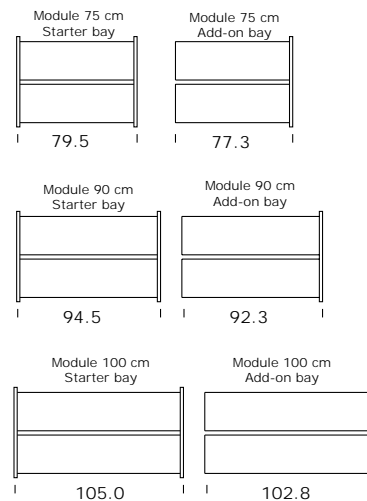

DEPTHS

The end panels come in 6 depths:
30.8 cm for 25 cm deep shelves
35.8 cm for 30 cm deep shelves
45.8 cm for 40 cm deep shelves
58.9 cm for 2 x 25 cm deep shelves
68.9 cm for 2 x 30 cm deep shelves
88.9 cm for 2 x 40 cm deep shelves

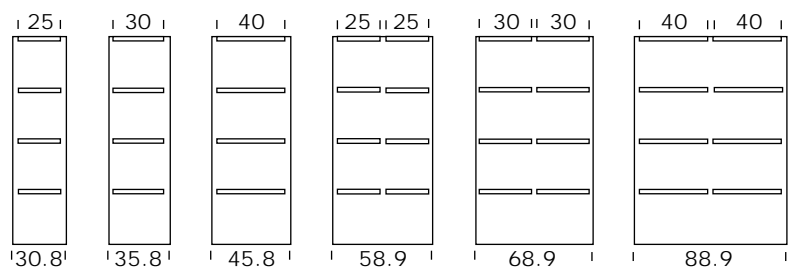

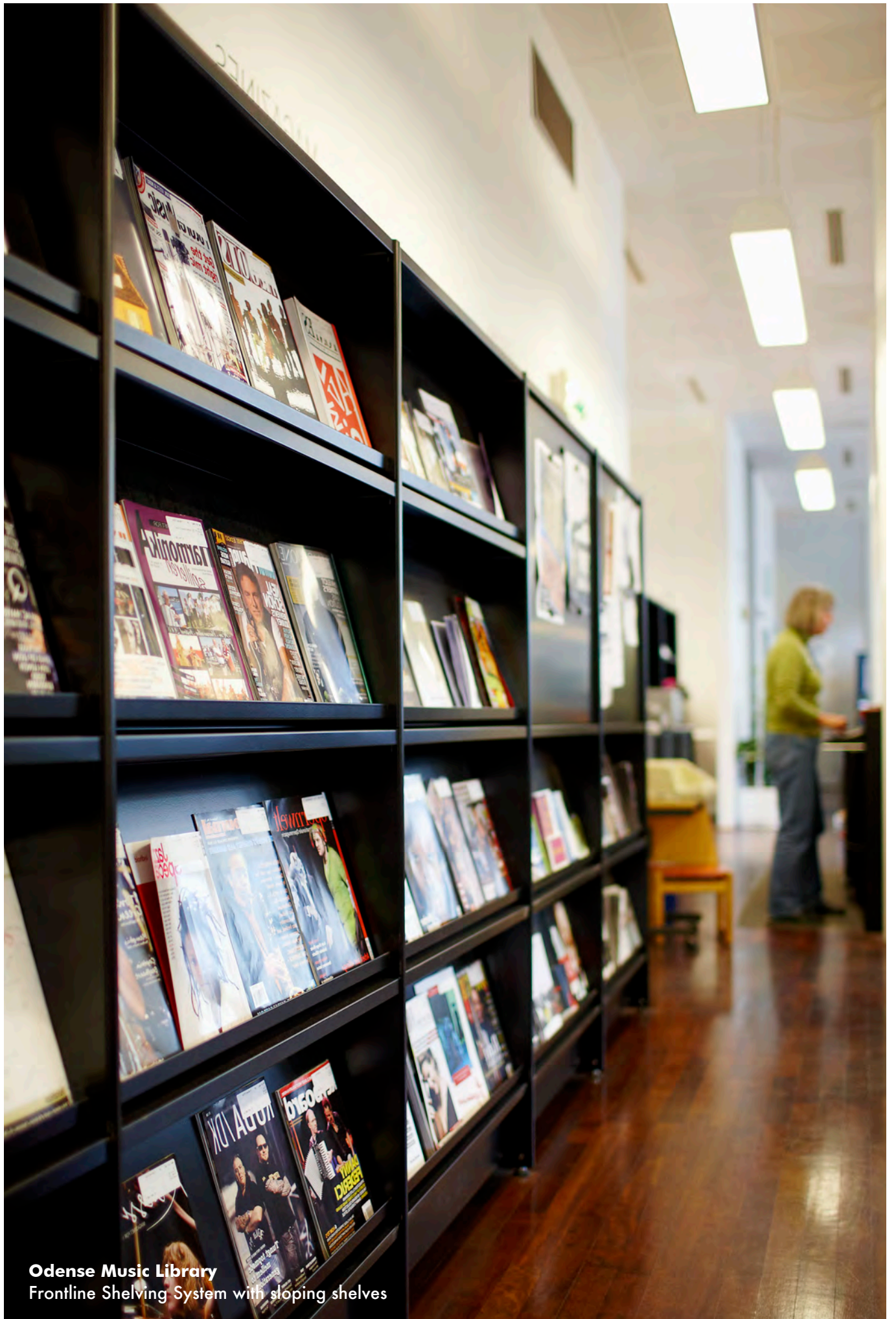

Odense Music Library
Frontline Shelving System with sloping shelves

FRONTLINE 22 SHELVING SYSTEM

The following pages will show basic configurations of the Frontline Shelving System with 22 mm thick end panels.

The Frontline end panels are available in two different thicknesses; 22 mm and 38 mm. If you wish Frontline 38 mm exchange the 22 mm components with 38 mm components. See under panels and shelves for overview of all 22 and 38 mm components. It is also possible to combine different thicknesses in the same shelving setting.

The Frontline end panel has a 4 mm flat front edge of solid wood. The distance between the front edge of the end panel and the front edge of the shelf is 5 mm.

Standard Frontline configurations are delivered in white beech, no. 55

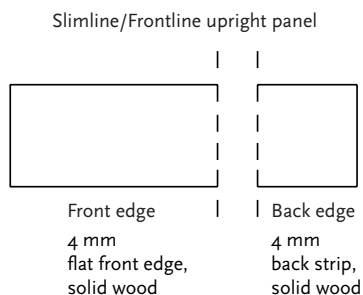

HEIGHTS

Frontline 22 shelving comes in 5 heights; 92, 122, 152, 182 and 212 cm. Heights include adjustable feet (max. 2 cm). The shelves are adjustable in 2.5 cm increments.

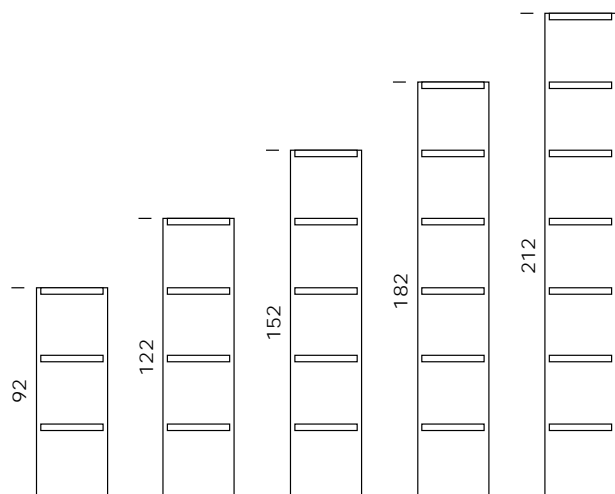

WIDTHS

The bays are available in 75, 90 and 100 cm modules and as starter and add-on bays. A starter bay has two outside end panels while an add-on bay has one intermediate end panel.

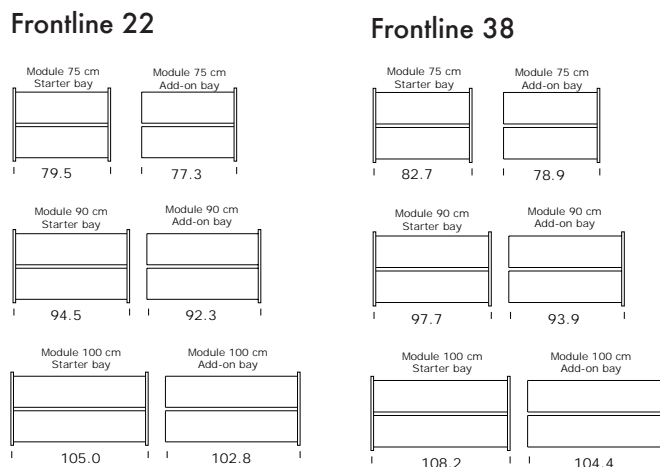

DEPTHS

The end panels come in 6 depths:
28.7 cm for 25 cm deep shelves
33.7 cm for 30 cm deep shelves
43.7 cm for 40 cm deep shelves
54.7 cm for 2 x 25 cm deep shelves
64.7 cm for 2 x 30 cm deep shelves
84.7 cm for 2 x 40 cm deep shelves

